

niermann

STAND BY



№33

nickelodeon





2017
Akku-Tischleuchte Paw Patrol

LED 1,5W, 5V, 2200mAh Akku,
bis 6 Std. Akkulaufzeit,
inkl. USB-Kabel, IP20, Acryl,
13 x 13 x 20 cm



40690
Wandleuchte Paw Patrol

1 x E14, max. 25W, 230V,
Eurostecker mit Zwischenschalter,
D = 25 cm



661
Deckenschale Paw Patrol

1 x E27, max. 15W, 230V,
nur für LED- oder Energiesparlampen,
IK-Stoßfestigkeitsgrad 06,
D = 36 cm, H = 10 cm



601
Strahler Paw Patrol

3 x GU10, max. 35W, 230V,
D = 35 cm





2018
Akku-Tischleuchte Brave Girls

LED 1,5W, 5V, 2200mAh Akku,
bis 6 Std. Akkulaufzeit,
inkl. USB-Kabel, IP20, Acryl,
13 x 13 x 20 cm



610
Strahler Pawsitive Pups

3 x GU10, max. 35W, 230V,
D = 35 cm



40689
Wandleuchte Pawsitive Pups

1 x E14, max. 25W, 230V,
Eurostecker mit Zwischenschalter,
D = 25 cm



separat erhältlich



157
Pendelaufhängung zu Papierballon

1 x E27, max. 60W, 230V,
Aufhängung ca. 45 cm,
höhenverstellbar



124
Pendelleuchte Papierballon
Paw Patrol

D = 40cm



80048
Stecker-Nachtlicht Paw Patrol, 3fach

projiziert 3 Motive im Wechsel an
die Zimmerdecke, LED, 1W, 230V,
Ein-Aus-Funktion über Dämmerungssensor,
100 x 90 x 100 mm

80049
Taschenlampen-Projektor Paw Patrol

4,5V für 3 Batterien AA, 1,5V,
es lassen sich 6 Motive per
Dreh-Rad auswählen und projizieren,
Batterien nicht im Lieferumfang enthalten,
ca. 7 x 15 cm



**6002
Strahler Dinos**

3 x GU10, max. 35W, 230V,
D = 35 cm



MADE IN GERMANY



**6502
Deckenschale Dinos**

1 x E27, max. 15W, 230V,
nur für LED- oder Energiesparlampen,
IK-Stoßfestigkeitsgrad 06,
D = 36 cm, H = 10 cm



**2012
Akku-Tischleuchte Dinos**

LED 1,5W, 5V, 2200mAh Akku,
bis 6 Std. Akkulaufzeit,
inkl. USB-Kabel, IP20, Acryl,
13 x 13 x 20 cm



**4002
Wandleuchte Dinos**

1 x E14, max. 25W, 230V,
Eurostecker mit Zwischenschalter,
D = 25 cm



MADE IN GERMANY



2002
Tisch-Leseleuchte Dinos

1 x GX53, 7-9W, 230V,
Eurostecker mit Zwischenschalter,
Flexrohr 25 cm fest + 25 cm flexibel



7002
Deckenleuchte Dinos

1 x E27, max. 15W,
230V + 20 LED Lichtpunkte,
Zugschalter mit Schlummerlichtfunktion,
Abdeckung aus PMMA,
IK-Stoßfestigkeitsgrad 06,
ca. 55 x 10 cm



1002
Stoff-Pendelleuchte Dinos

1 x E27, max. 60W, 230V,
ca. 35 x 17 cm,
Aufhängung ca. 45 cm, höhenverstellbar





6003
Strahler Weltall

3 x GU10, max. 35W, 230V,
D = 35 cm



6503
Deckenschale Weltall

1 x E27, max. 15W, 230V,
nur für LED- oder Energiesparlampen,
IK-Stoßfestigkeitsgrad 06,
D = 36 cm, H = 10 cm



2013
Akku-Tischleuchte Weltall

LED 1,5W, 5V, 2200mAh Akku,
bis 6 Std. Akkulaufzeit,
inkl. USB-Kabel, IP20, Acryl,
13 x 13 x 20 cm



4003
Wandleuchte Weltall

1 x E14, max. 25W, 230V,
Eurostecker mit Zwischenschalter,
D = 25 cm





2003
Tisch-Leseleuchte Weltall

1 x GX53, 7-9W, 230V
Eurostecker mit Zwischenschalter,
Flexrohr 25 cm fest + 25 cm flexibel



7003
Deckenleuchte Weltall

1 x E27, max. 15W,
230V + 20 LED Lichtpunkte
Zugschalter mit Schlummerlichtfunktion,
IK-Stoßfestigkeitsgrad 06,
Abdeckung aus PMMA,
ca. 55 x 10 cm



1003
Stoff-Pendelleuchte Weltall

1 x E27, max. 60W, 230V,
ca. 35 x 17 cm,
Aufhängung ca. 45 cm, höhenverstellbar





4004
Wandleuchte Baustelle

1 x E14, max. 25W, 230V,
Eurostecker mit Zwischenschalter,
D = 25 cm



MADE IN GERMANY



6004
Strahler Baustelle

3 x GU10, max. 35W, 230V,
D = 35 cm



MADE IN GERMANY



2014
Akku-Tischleuchte Baustelle

LED 1,5W, 5V, 2200mAh Akku,
bis 6 Std. Akkulaufzeit,
inkl. USB-Kabel, IP20, Acryl,
13 x 13 x 20 cm



1004
Stoff-Pendelleuchte Baustelle

1 x E27, max. 60W, 230V,
ca. 35 x 17 cm,
Aufhängung ca. 45 cm, höhenverstellbar



MADE IN GERMANY



7004
Deckenleuchte Baustelle

1 x E27, max. 15W,
230V + 20 LED Lichtpunkte,
Zugschalter mit Schlummerlichtfunktion,
IK-Stoßfestigkeitsgrad 06,
Abdeckung aus PMMA,
ca. 55 x 10 cm



2004
Tisch-Leseleuchte Baustelle

1 x GX53, 7-9W, 230V,
Eurostecker mit Zwischenschalter,
Flexrohr 25 cm fest + 25 cm flexibel,



6504
Deckenschale Baustelle

1 x E27, max. 15W, 230V,
nur für LED- oder Energiesparlampen,
IK-Stoßfestigkeitsgrad 06,
D = 36 cm, H = 10 cm





**250
Tisch-Leseleuchte Princess**

1 x GX53, 7-9W, 230V,
Eurostecker mit Zwischenschalter,
Flexrohr 25 cm fest + 25 cm flexibel



**40680
Wandleuchte Princess**

1 x E14, max. 25W, 230V,
Eurostecker mit Zwischenschalter,
D = 25 cm

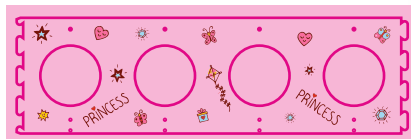

**177
Dreh-Pendelleuchte Princess**

1 x E27, max. 60W, 230V,
ca. 27 x 25 cm,
Aufhängung ca. 45 cm,
höhenverstellbar



**337
Wand-Leseleuchte Princess**

1 x GX53, max. 9W, 230V, Flexrohr 30 cm,
Eurostecker mit Zwischenschalter





**650
Strahler Princess**

3 x GU10, max. 35W, 230V,
D = 35 cm



MADE IN GERMANY

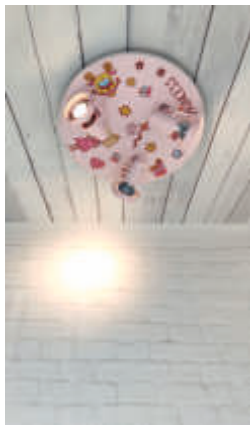

**923
Garderobe Princess**

55 x 38 cm



MADE IN GERMANY

**80051
Stecker-Nachtlicht Princess, 3fach**

projiziert 3 Motive im Wechsel an
die Zimmerdecke, LED, 1W, 230V,
Ein-Aus-Funktion über Dämmerungssensor,
100 x 90 x 100 mm



**80050
Stecker-Nachtlicht Princess**

projiziert ein Motiv an
die Zimmerdecke, LED, 1W, 230V,
Ein-Aus-Funktion über Dämmerungssensor
90 x 80 x 70 mm



**80052
Taschenlampen-Projektor Princess**

4,5V für 3 Batterien AA, 1,5V,
es lassen sich 6 Motive per
Dreh-Rad auswählen und projizieren,
Batterien nicht im Lieferumfang enthalten,
ca. 7 x 15 cm



251
Tisch-Leseleuchte Waldtiere

1 x GX53, 7-9W, 230V
Eurostecker mit Zwischenschalter,
Flexrohr 25 cm fest + 25 cm flexibel



40681
Wandleuchte Waldtiere

1 x E14, max. 25W, 230V,
Eurostecker mit Zwischenschalter,
D = 25 cm

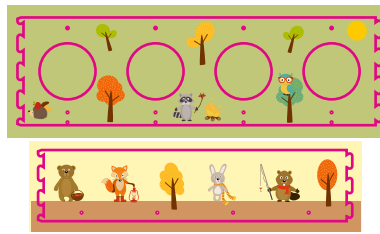

178
Dreh-Pendelleuchte Waldtiere

1 x E27, max. 60W, 230V,
ca. 27 x 25 cm,
Aufhängung ca. 45 cm,
höhenverstellbar



338
Wand-Leseleuchte Waldtiere

1 x GX53, max. 9W, 230V, Flexrohr 30 cm,
Eurostecker mit Zwischenschalter



2019
Akku-Tischleuchte Waldtiere

LED 1,5W, 5V, 2200mAh Akku,
bis 6 Std. Akkulaufzeit,
inkl. USB-Kabel, IP20, Acryl,
13 x 13 x 20 cm



**614
Strahler Waldtiere**

3 x GU10, max. 35W, 230V,
D = 35 cm



**765
Deckenleuchte Waldtiere**

1 x E27, max. 15W,
230V + 20 LED Lichtpunkte,
Zugschalter mit Schummerlichtfunktion,
IK-Stoßfestigkeitsgrad 06,
Abdeckung aus PMMA,
ca. 55 x 10 cm



**756
Deckenschale Waldtiere**

1 x E27, max. 15W, 230V,
nur für LED- oder Energiesparlampen,
IK-Stoßfestigkeitsgrad 06,
D = 36 cm, H = 10 cm



**922
Garderobe Waldtiere**

55 x 38 cm



**80053
Stecker-Nachtlicht Waldtiere**

projiziert ein Motiv an
die Zimmerdecke, LED, 1W, 230V,
Ein-Aus-Funktion über Dämmerungssensor,
90 x 80 x 70 mm



**80055
Taschenlampen-Projektor Waldtiere**

4,5V für 3 Batterien AA, 1,5V,
es lassen sich 6 Motive per
Dreh-Rad auswählen und projizieren,
Batterien nicht im Lieferumfang enthalten,
ca. 7 x 15 cm



**80054
Stecker-Nachtlicht Waldtiere, 3fach**

projiziert 3 Motive im Wechsel an
die Zimmerdecke, LED, 1W, 230V,
Ein-Aus-Funktion über Dämmerungssensor,
100 x 90 x 100 mm



**116
Stoff-Pendelleuchte Fahrzeuge**

1 x E27, max. 60W, 230V,
ca. 35 x 17 cm,
Aufhängung ca. 45 cm, höhenverstellbar



**618
Strahler Fahrzeuge**

3 x GU10, max. 35W, 230V,
D = 35 cm

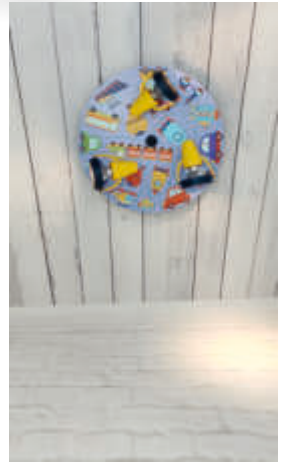

**6001
Deckenleuchte Fahrzeuge**

1 x E27, max. 15W,
230V + 20 LED Lichtpunkte,
Zugschalter mit Schlummerlichtfunktion,
IK-Stoßfestigkeitsgrad 06,
Abdeckung aus PMMA,
ca. 55 x 10 cm



**40682
Wandleuchte Fahrzeuge**

1 x E14, max. 25W, 230V,
Eurostecker mit Zwischenschalter,
D = 25 cm





352
Wand-Leseleuchte Fahrzeuge

1 x GX53, max. 9W, 230V, Flexrohr 30 cm,
Eurostecker mit Zwischenschalter



252
Tisch-Leseleuchte Fahrzeuge

1 x GX53, 7-9W, 230V,
Eurostecker mit Zwischenschalter,
Flexrohr 25 cm fest + 25 cm flexibel,



699
Deckenschale Fahrzeuge

1 x E27, max. 15W, 230V,
nur für LED- oder Energiesparlampen,
IK-Stoßfestigkeitsgrad 06,
D = 36 cm, H = 10 cm



154
Pendelleuchte Papierballon
Sunny

D = 40cm

separat erhältlich



157
Pendelaufhängung zu Papierballon

1 x E27, max. 60W, 230V,
Aufhängung ca. 45 cm,
höhenverstellbar



120
Dreh-Pendelleuchte Sunny

1 x E27, max. 60W, 230V,
ca. 27 x 25 cm,
Aufhängung ca. 45 cm, höhenverstellbar



MADE IN GERMANY



6020
Strahler Sunny

3 x GU10, max. 35W, 230V,
55 x 38 x 15 cm



MADE IN GERMANY



40688
Wandleuchte Sunny

1 x E14, max. 25W, 230V,
Eurostecker mit Zwischenschalter,
D = 25 cm



MADE IN GERMANY



**681
Deckenschale Sunny**

1 x E27, max. 15W, 230V,
nur für LED- oder Energiesparlampen,
IK-Stoßfestigkeitsgrad 06,
D = 36 cm, H = 10 cm

**920
Garderobe Sunny**

55 x 38 cm



MADE IN GERMANY

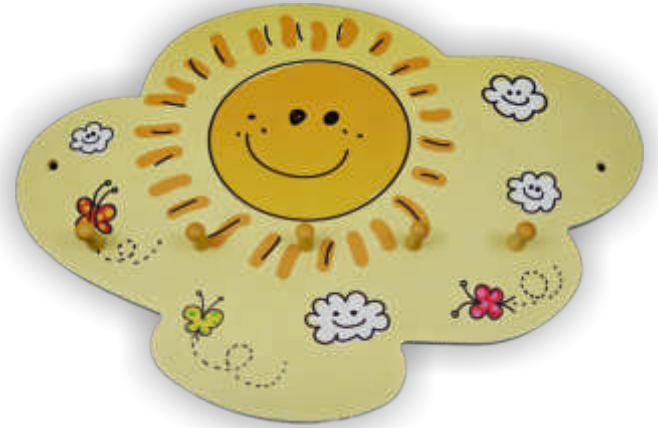

**80039
Stecker-Nachtlicht Sunny**

projiziert ein Motiv an die Zimmerdecke,
LED, 1W, 230V,
Ein-Aus-Funktion über Dämmerungssensor,
90 x 80 x 70 mm



**2015
Akku-Tischleuchte Sunny**

LED 1,5W, 5V, 2200mAh Akku,
bis 6 Std. Akkulaufzeit,
inkl. USB-Kabel, IP20, Acryl,
13 x 13 x 20 cm



**204
Tisch-Leseleuchte Sunny**

1 x GX53, 7-9W, 230V,
Eurostecker mit Zwischenschalter,
Flexrohr 25 cm fest + 25 cm flexibel



MADE IN GERMANY

separat erhältlich



157
Pendelaufhängung zu Papierballon

1 x E27, max. 60W, 230V,
Aufhängung ca. 45 cm,
höhenverstellbar

108
Pendelleuchte Papierballon
Fußball

D = 40cm



218
Tisch-Leseleuchte Fußballfeld

1 x GX53, 7-9W, 230V,
Eurostecker mit Zwischenschalter,
Flexrohr 25 cm fest + 25 cm flexibel



253
Tisch-Leseleuchte Fußball

1 x GX53, 7-9W, 230V,
Eurostecker mit Zwischenschalter,
Flexrohr 25 cm fest + 25 cm flexibel



40691
Wandleuchte Fußball

1 x E14, max. 25W, 230V,
Eurostecker mit Zwischenschalter,
D = 25 cm





697
Strahlerleiste Fußball, schwarz/titan

mit 4 verstellbaren Spots
4 x GU10, max. 35W, 230V
70 x 17 x 9 cm



MADE IN GERMANY



678
Deckenschale Fußball

1 x E27, max. 15W, 230V,
nur für LED- oder Energiesparlampen,
IK-Stoßfestigkeitsgrad 06,
D = 36 cm, H = 10 cm



339
Wand-Leseleuchte Fußball

1 x GX53, max. 9W, 230V, Flexrohr 30 cm,
Eurostecker mit Zwischenschalter



MADE IN GERMANY



604
Strahler Fußball

3 x GU10, max. 35W, 230V,
D = 35 cm



MADE IN GERMANY



668
Deckenleuchte Fußballstadion

5 x E14, max. 25W,
230V + 20 LED Lichtpunkte,
Zugschalter für
Schlummerlichtfunktion,
53 x 71 x 7 cm



926
Garderobe Fußball

55 x 38 cm

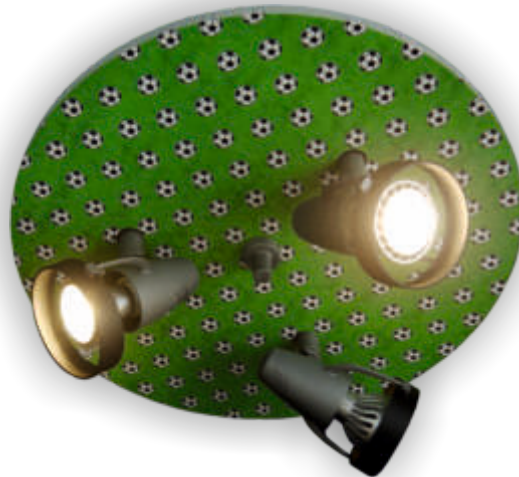

602
Strahler Fußballle

3 x GU10, max. 35W, 230V,
D = 35 cm



657
Deckenleuchte Fußballle

5 x E14, max. 25W,
230V + 20 LED Lichtpunkte,
Zugschalter für
Schlummerlichtfunktion,
53 x 71 x 7 cm

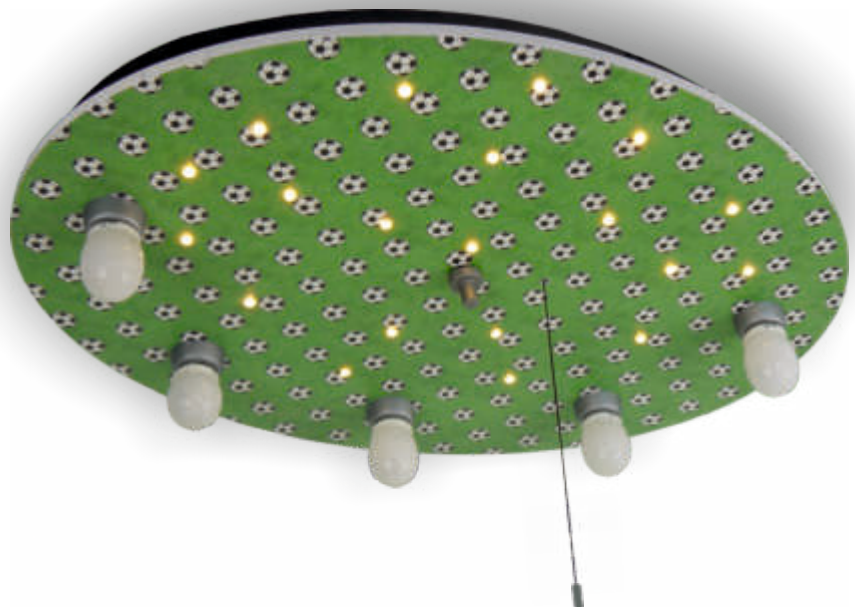

Tischleuchten





2125
Akku-Tischleuchte salbeigrün,
mit Mond und Sternen



2126
Akku-Tischleuchte petrol,
mit Mond und Sternen



2127
Akku-Tischleuchte rosa,
mit Mond und Sternen



2128
Akku-Tischleuchte sonnengelb,
mit Mond und Sternen

Foto folgt in kürze

2129
Akku-Tischleuchte peach fuzz,
mit Mond und Sternen

Alle Leuchten auf dieser Seite:

LED 1,5W, 5V, 2200mAh Akku,
bis 6 Std. Akkulaufzeit,
inkl. USB-Kabel, IP20, Acryl,
13 x 13 x 20 cm





2025
Akku-Tischleuchte salbeigrün



2026
Akku-Tischleuchte petrol



2027
Akku-Tischleuchte rosa



2028
Akku-Tischleuchte sonnengelb



2027
Akku-Tischleuchte peach fuzz

Alle Leuchten auf dieser Seite:

LED 1,5W, 5V, 2200mAh Akku,
bis 6 Std. Akkulaufzeit,
inkl. USB-Kabel, IP20, Acryl,
13 x 13 x 20 cm





2012
Akku-Tischleuchte Dino



2013
Akku-Tischleuchte Weltall



2014
Akku-Tischleuchte Baustelle



2015
Akku-Tischleuchte Sunny



2016
Akku-Tischleuchte Waldtiere

Alle Leuchten auf dieser Seite:

LED 1,5W, 5V, 2200mAh Akku,
bis 6 Std. Akkulaufzeit,
inkl. USB-Kabel, IP20, Acryl,
13 x 13 x 20 cm

2017

Akku-Tischleuchte Paw Patrol

LED 1,5W, 5V, 2200mAh Akku,
bis 6 Std. Akkulaufzeit,
inkl. USB-Kabel, IP20, Acryl,
13 x 13 x 20 cm



2018

Akku-Tischleuchte Brave Girls

LED 1,5W, 5V, 2200mAh Akku,
bis 6 Std. Akkulaufzeit,
inkl. USB-Kabel, IP20, Acryl,
13 x 13 x 20 cm



2005 - salbeigrün



2006 - petrol



2007 - pastelrosé



2008 - sonnengelb



2009 - peach fuzz



Alle Leuchten auf dieser Seite:

1 x GX53, 7-9W, 230V,
Eurostecker mit Zwischenschalter,
Flexrohr 25 cm fest + 25 cm flexibel



200 - Automobile



204 - Sunny



216 - Frosch



218 - Fußballfeld



Alle Leuchten auf dieser Seite:

1 x GX53, 7-9W, 230V,
Eurostecker mit Zwischenschalter,
Flexrohr 25 cm fest + 25 cm flexibel



MADE IN GERMANY



2002 - Dinos

Alle Leuchten auf dieser Seite:

1 x GX53, 7-9W, 230V,
Eurostecker mit Zwischenschalter,
Flexrohr 25 cm fest + 25 cm flexibel



2003 - Weltall



2004 - Baustelle



250 - Princess



251 - Waldtiere



252 - Fahrzeuge



253 - Fußball



202 - Kleiner Prinz

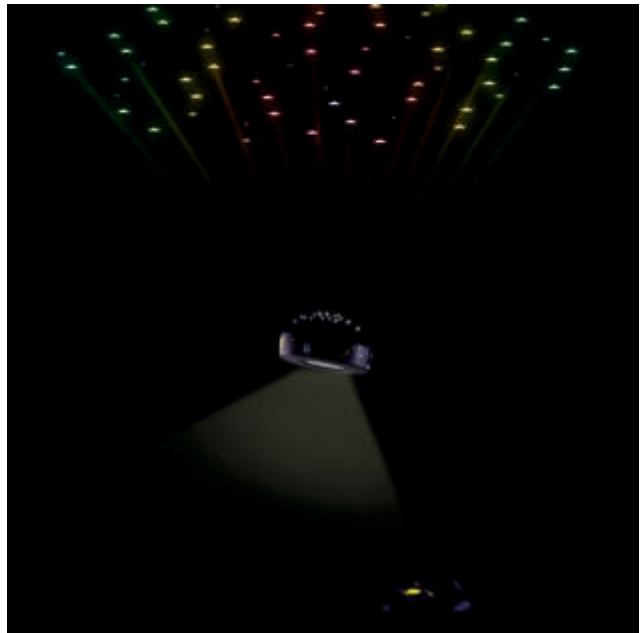

Alle Leuchten auf dieser Seite:

6,3W, 5000 K, 400LM, 12V,
EIN-AUS-Funktion über Touchdimmer,
24 x 14 x 50 cm

2 Funktionen:

1. Leseleuchte mit Touchdimmer
2. Projektionsnachtlicht mit Farbwechsler

201 - Starbee

50153 - Kleiner Prinz



Projiziert Sterne in den ganzen Raum.



50682 - Margeriten



Projiziert Herzen in den ganzen Raum.



Alle Leuchten auf dieser Seite:

1 x G4, 20W, 12V,
Steckertrafo mit Zwischenschalter,
H = 35 cm, D = 20 cm



Deckenleuchten





6003 - Weltall



6002 - Dinos



6004 - Baustelle



610 - Pawsitive Pups



601 - Paw Patrol



650 - Princess



614 - Waldtiere



618 - Fahrzeuge



604 - Fußball

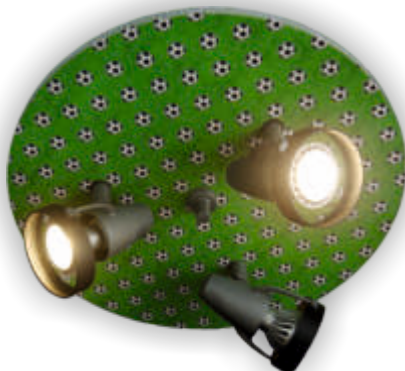

602 - Fußbälle



6020 - Sunny



Alle Leuchten auf dieser Seite:

3 x GU10, max. 35W, 230V,
D = 35 cm



MADE IN GERMANY



6005 - salbeigrün



6006 - petrol

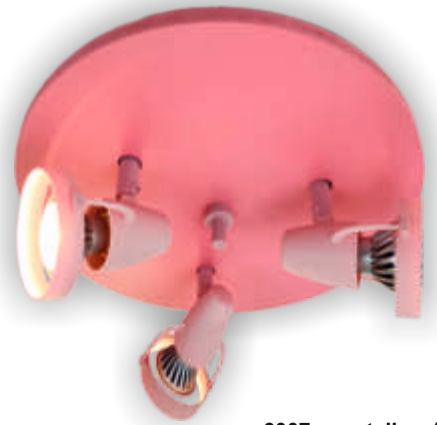

6007 - pastellrosé



6008 - sonnegelb



6009 - peach fuzz

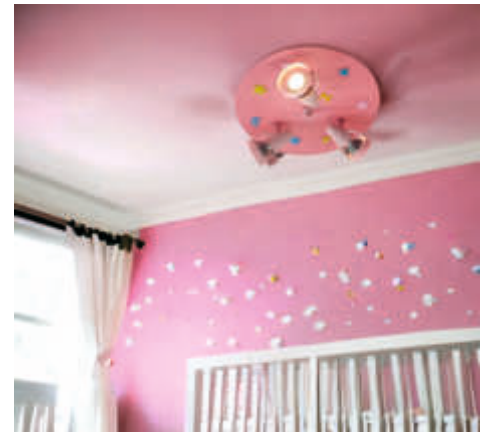

6021 - rosa/Rosen



6022- Blumenwiese, rosa



Alle Leuchten oben:

3 x GU10, max. 35W, 230V,
D = 35 cm



MADE IN GERMANY



696
Strahlerleiste Mond und Sterne, blau/gelb

mit 4 verstellbaren Spots,
4 x GU10, max. 35W, 230V,
70 x 17 x 9 cm



MADE IN GERMANY



697
Strahlerleiste Fußball, schwarz/titan

mit 4 verstellbaren Spots,
4 x GU10, max. 35W, 230V,
70 x 17 x 9 cm



MADE IN GERMANY



766 - Kleiner Prinz



643 - Sternenhimmel



644 - Gothic

Alle Leuchten auf dieser Seite:

5 x E14, max. 25W,
230V + 20 LED Lichtpunkte,
Zugschalter für
Schlummerlichtfunktion,
53 x 71 x 7 cm

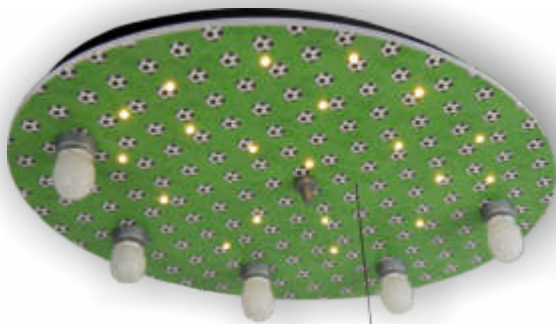

657 - Fußballbälle



668 - Fußballstadion



642 - blau mit leuchtenden Sternen



641 - Bärchen



7003 - Weltall



7004 - Baustelle



7002 - Dinos



6001- Fahrzeuge



765 - Waldtiere

Alle Leuchten auf dieser Seite:

1 x E27, max. 15W,
230V + 20 LED Lichtpunkte,
Zugschalter mit Schummerlichtfunktion,
IK-Stoßfestigkeitsgrad 06,
Abdeckung aus PMMA,
ca. 55 x 10 cm





7005 - Starlight, salbeigrün



7006 - Starlight, petrol



7007 - Starlight, pastellrosé



7008 - Starlight, sonnengelb



7009 - Starlight, peach fuzz



Alle Leuchten auf dieser Seite:

1 x E27, max. 15W,
230V + 20 LED Lichtpunkte,
Zugschalter mit Schlummerlichtfunktion,
IK-Stoßfestigkeitsgrad 06,
Abdeckung aus PMMA,
ca. 55 x 10 cm



MADE IN GERMANY



6505 - Saturn, salbeigrün



6506 - Saturn, petrol



6507 - Saturn, pastellrosé



6508 - Saturn, sonnengelb



6512- Saturn, peach fuzz



Alle Leuchten auf dieser Seite:

1 x E27, max. 15W, 230V,
nur für LED- oder Energiesparlampen,
IK-Stoßfestigkeitsgrad 06, PMMA,
D = ca. 53 cm, D (Schale) = 36 cm,
H= 10cm,



MADE IN GERMANY



6605 - Stern, salbeigrün



6606 - Stern, petrol



6607 - Stern, pastellosé



6608 - Stern, sonnengelb



6609 - Stern, peach fuzz



6610 - Stern, silber



6611 - Stern, gold

Alle Leuchten auf dieser Seite:

1 x E27, max. 15W, 230V,
nur für LED- oder Energiesparlampen,
IK-Stoßfestigkeitsgrad 06, PMMA,
D = ca. 53 cm, D (Schale) = 36 cm,
H= 10cm,



6508 - Saturn, gold

1 x E27, max. 15W, 230V,
nur für LED- oder Energiesparlampen,
IK-Stoßfestigkeitsgrad 06, PMMA,
D = ca. 53 cm, D (Schale) = 36 cm,
H= 10cm



6509 - Saturn, silber

1 x E27, max. 15W, 230V,
nur für LED- oder Energiesparlampen,
IK-Stoßfestigkeitsgrad 06, PMMA,
D = ca. 53 cm, D (Schale) = 36 cm,
H= 10cm



7009 - Starlight, gold

1 x E27, max. 15W,
230V + 20 LED Lichtpunkte,
Zugschalter mit Schlummerlichtfunktion,
IK-Stoßfestigkeitsgrad 06, PMMA,
ca. 55 x 10 cm

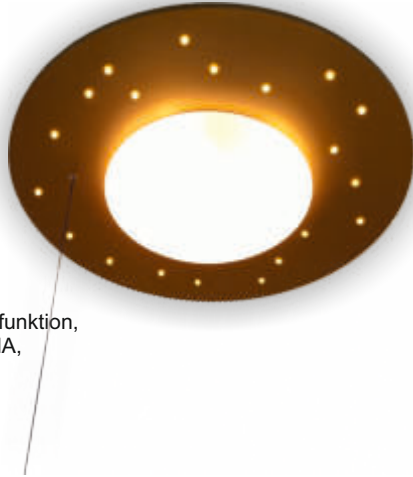

7010 - Starlight, silber

1 x E27, max. 15W,
230V + 20 LED Lichtpunkte,
Zugschalter mit Schlummerlichtfunktion,
IK-Stoßfestigkeitsgrad 06, PMMA,
ca. 55 x 10 cm

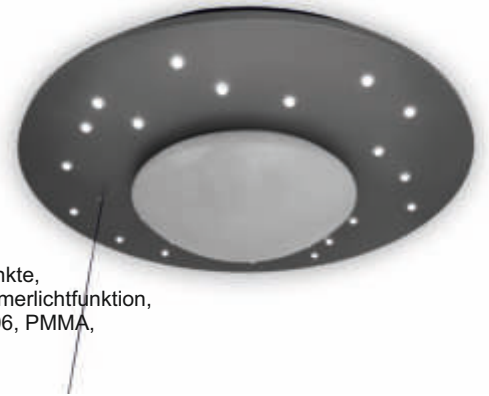

7011 - Wolke, gold

5 x E14, max. 25W,
230V + 20 LED Lichtpunkte,
Zugschalter für
Schlummerlichtfunktion,
53 x 71 x 7 cm



767 - Wolke, titan

5 x E14, max. 25W,
230V + 20 LED Lichtpunkte,
Zugschalter für
Schlummerlichtfunktion,
Sterne abnehmbar,
53 x 71 x 7 cm



6511 - Sonne, gold

1 x E27, max. 15W, 230V,
nur für LED- oder Energiesparlampe,
IK-Stoßfestigkeitsgrad 06, PMMA,
D = ca. 53 cm, D (Schale) = 36 cm,
H= 10cm

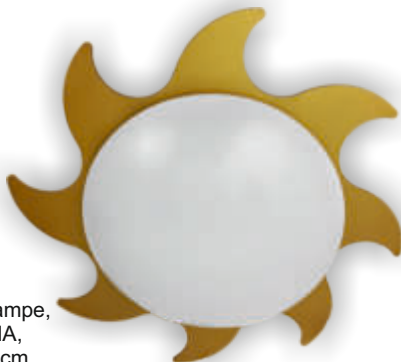



661 - Paw Patrol



678 - Fußball



681 - Sunny



6502 - Dino



6503 - Weltall



6504 - Baustelle



756 - Waldtiere



699 - Fahrzeuge



676 - Bär Berni

Alle Leuchten auf dieser Seite (außer 676):

1 x E27, max. 15W, 230V,
nur für LED- oder Energiesparlampen,
IK-Stoßfestigkeitsgrad 06, PMMA,
D = 36 cm, H = 10 cm

2 x E27, max. 15W, 230V,
nur für LED- oder Energiesparlampen,
IK-Stoßfestigkeitsgrad 06, PMMA,
D = 45 cm, H = 11 cm



HCL Human Centric Lighting

Eine biologische Beleuchtung kann die Lebensqualität des Menschen entscheidend verbessern.

- bessere Konzentration
- Motivationssteigerung
- verbesserter Tag/Nacht-Rhythmus

Das von zwei Niederländern erfundene snoezelen ist eine Kombination aus snuffelen und doezelen. Ein Snoezelraum bietet die Möglichkeit, mit sanftem Licht und unterschiedlichen Lichtspielen die Sinne und Gefühle anzuregen.

Im Snoezelraum soll dem Kind das Abschalten erleichtert werden. Durch den Einsatz von speziellem Licht, Entspannungsmusik oder Traumreisen können die Kinder zur Ruhe kommen, entspannen und träumen.

Unsere HCL-Leuchten verfügen über zwei Zugtaster zur Einstellung der Farbtemperatur und der Dimmfunktion. Die Farbtemperatur lässt sich stufenlos von 2700 bis 5000 Kelvin einstellen.

665 Deckenleuchte Sternenhimmel HCL

LED 22W, 2100 Lumen,
2700-5000 Kelvin,
mit Zugtastern,
IK-Stoßfestigkeitsgrad 06, PMMA,
57 x 74 x 7 cm



MADE IN GERMANY



1002 - Dinos



1003 - Weltall



1004 - Baustelle



116 - Fahrzeuge



130 - Herzen rosa/pink



133 - Miniherzen weiß/rosa

Alle Leuchten auf dieser Seite:

Textil-Lampenschirm,
1 x E27, max. 60W, 230V,
ca. 35 x 17 cm,
Aufhängung ca. 45 cm, höhenverstellbar



MADE IN GERMANY



120 - Sunny



123 - Bärchen



166 - Kleiner Prinz



171 - Automobile



172 - Explore



173 - Zanimo



174 - Aliens

Alle Leuchten auf dieser Seite:

1 x E27, max. 60W, 230V,
ca. 27 x 25 cm,
Aufhängung ca. 45 cm, höhenverstellbar,
innerer Lampenschirm dreht
sich solarbetrieben





1001 - weiß



107 - Bunte Blumen



108 - Fußball



153 - Kleiner Prinz



154 - Sunny



124 - Paw Patrol

Alle Lampenschirme auf dieser Seite:

D = 40cm

separat erhältlich



157
Pendelaufhängung zu Papierballon

1 x E27, max. 60W, 230V,
Aufhängung ca. 45 cm,
höhenverstellbar





144 - Pferd

1 x E27, max. 60W, 230V,
ca. 40 x 30 x 20 cm



145 - Giraffe

1 x E27, max. 60W, 230V,
ca. 40 x 30 x 20 cm



146 - Kuh

1 x E27, max. 60W, 230V,
ca. 40 x 30 x 20 cm



156 - Estelle

1 x E27, max. 60W, 230V,
ca. 32 x 23 cm



179 - Lüster Rosata

1 x E27, max. 60W, 230V,
ca. 55 x 40 cm



183 - Hubschrauber

1 x E27, max. 15W, 230V,
ca. 45 x 30 x 30 cm



188 - Feuerwehrauto

1 x E27, max. 15W, 230V,
ca. 32 x 34 x 6 cm

Alle Leuchten auf dieser Seite:

Aufhängung ca. 45 cm, höhenverstellbar



MADE IN GERMANY

Wandleuchten





4005 - salbeigrün, mit Sternen



4006 - petrol, mit Sternen



4007 - rosa, mit Sternen



4008 - sonnengelb, mit Sternen



400p - peach fuzz, mit Sternen



Alle Leuchten auf dieser Seite:

1 x E14, max. 25W, 230V,
Eurostecker mit Zwischenschalter,
D = 25 cm



MADE IN GERMANY



4002 - Dinos



4003 - Weltall



4003 - Baustelle



40680 - Princess



40681 - Waldtiere



40682 - Fahrzeuge



40683 - Libelle



40684 - Fische



40686 - Wilde Tiere



40687 - Kleiner Prinz



40688 - Sunny



40689 - Pawsitive Pups



40690 - Paw Patrol



40691 - Fußball

Alle Leuchten auf dieser Seite:
1 x E14, max. 25W, 230V,
Eurostecker mit Zwischenschalter,
D = 25 cm





3002 - Dinos



3003 - Weltall



3004 - Baustelle



337 - Princess

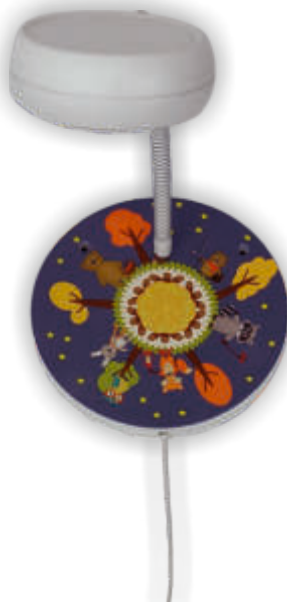

338 - Waldtiere



352 - Fahrzeuge



339 - Fußball

Alle Leuchten auf dieser Seite:

1 x GX53, max. 9W, 230V, Flexrohr 30 cm,
Eurostecker mit Zwischenschalter



328 - Clown

1 x E14, max. 40W, 230V,
Flexrohr 30 cm,
Schuko-stecker mit
Zwischenschalter



Nachtlichter

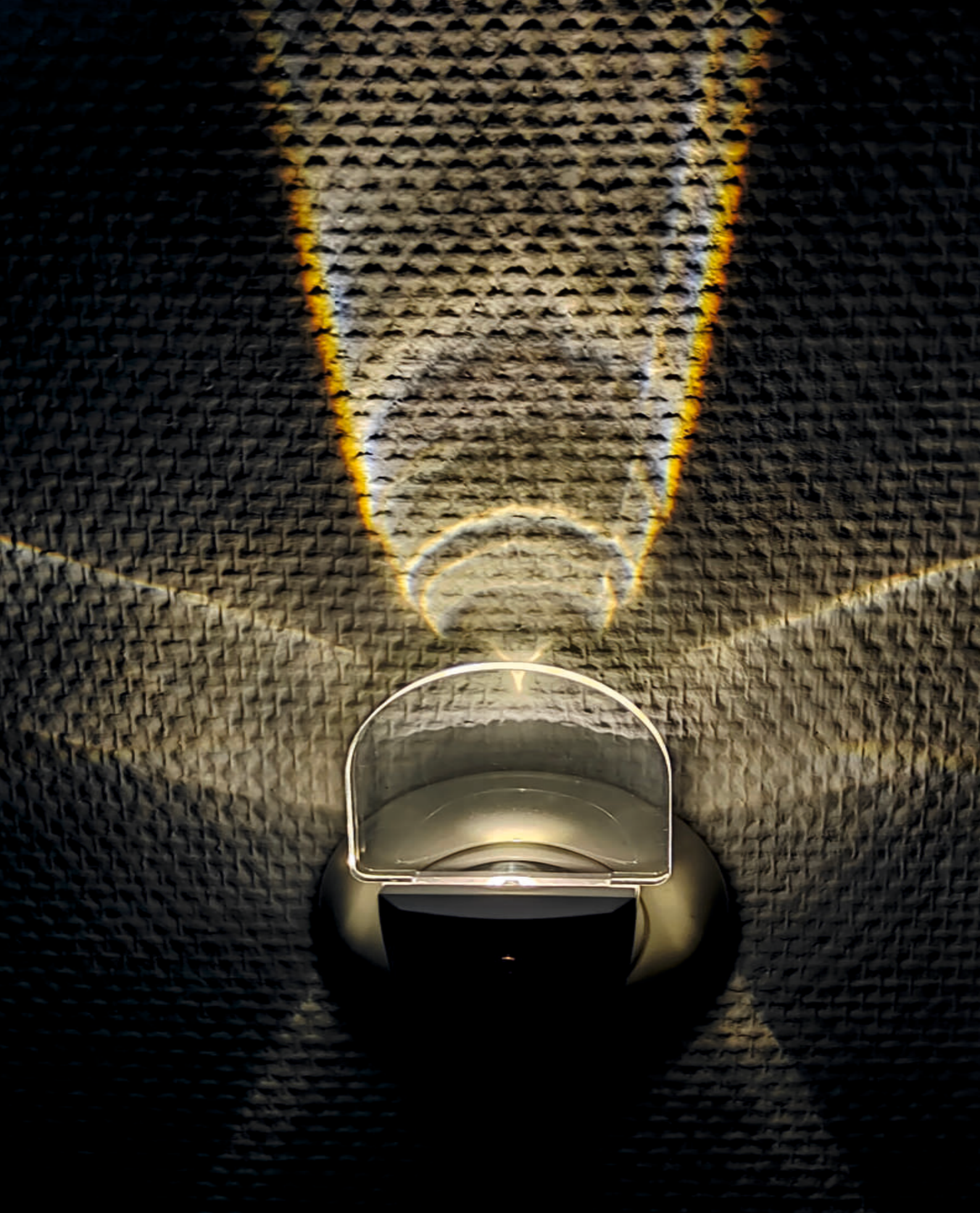



80020
Nachtlicht Ring

LED, 0,5W, 230V,
Ein-Aus-Funktion
über Dämmerungssensor,
85 x 85 x 80 mm



80021
Nachtlicht-Projektor mit Farbwechsler

projiziert Lichteffekte an die Wand,
LED, 0,5W, 230V,
Ein-Aus-Funktion über Dämmerungssensor,
82 x 56 x 80 mm

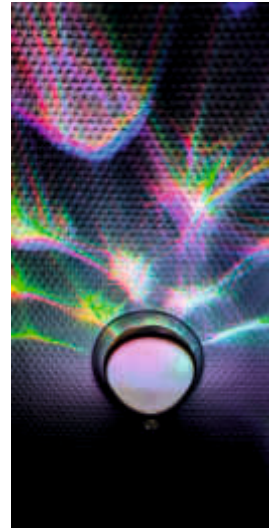

80022
Nachtlicht 360° Rotation

LED, 0,5W, 230V,
Ein-Aus-Funktion über Dämmerungssensor,
82 x 56 x 80 mm



80023
Nachtlicht Oval

LED, 0,5W, 230V,
Ein-Aus-Funktion über Dämmerungssensor,
10 x 55 x 70 mm

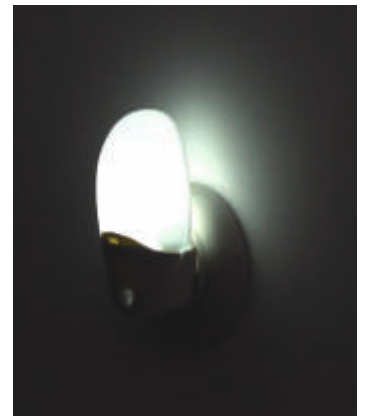

80024
Nachtlicht 3 in 1 Multifunktions-LED

- Nachtlicht mit Auto Ein-Aus-Funktion
- Notbeleuchtung bei Stromausfall
- Taschenlampe
0,7W, 230V,
Ein-Aus-Funktion über Dämmerungssensor,
120 x 40 x 80 mm

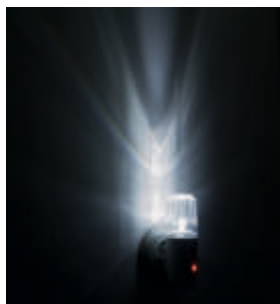

80025
Nachtlicht Slim

LED, 0,5W, 230V,
Ein-Aus-Funktion
über Dämmerungssensor,
95 x 58 x 60 mm

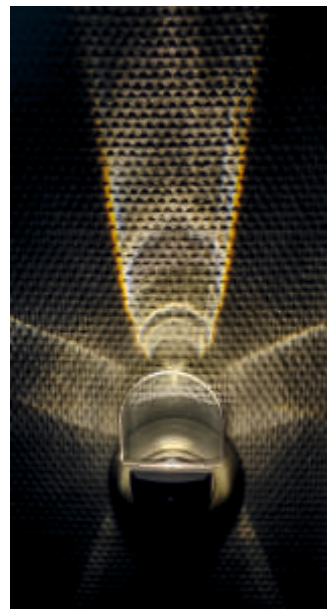



80047
Stecker-Nachtlicht Paw Patrol

projiziert ein Motiv an die Zimmerdecke, LED, 1W, 230V, Ein-Aus-Funktion über Dämmerungssensor, 90 x 80 x 70 mm



80048
Stecker-Nachtlicht Paw Patrol, 3fach

projiziert 3 Motive im Wechsel an die Zimmerdecke, LED, 1W, 230V, Ein-Aus-Funktion über Dämmerungssensor, 100 x 90 x 100 mm



80049
Taschenlampen-Projektor Paw Patrol

4,5V für 3 Batterien AA, 1,5V, es lassen sich 6 Motive per Dreh-Rad auswählen und projizieren, Batterien nicht im Lieferumfang enthalten, ca. 7 x 15 cm



80050
Stecker-Nachtlicht Princess

projiziert ein Motiv an die Zimmerdecke, LED, 1W, 230V, Ein-Aus-Funktion über Dämmerungssensor, 90 x 80 x 70 mm



80051
Stecker-Nachtlicht Princess, 3fach

projiziert 3 Motive im Wechsel an die Zimmerdecke, LED, 1W, 230V, Ein-Aus-Funktion über Dämmerungssensor, 100 x 90 x 100 mm



80052
Taschenlampen-Projektor Princess

4,5V für 3 Batterien AA, 1,5V, es lassen sich 6 Motive per Dreh-Rad auswählen und projizieren, Batterien nicht im Lieferumfang enthalten, ca. 7 x 15 cm



80053
Stecker-Nachtlicht Waldtiere

projiziert ein Motiv an die Zimmerdecke, LED, 1W, 230V, Ein-Aus-Funktion über Dämmerungssensor, 90 x 80 x 70 mm



80054
Stecker-Nachtlicht Waldtiere, 3fach

projiziert 3 Motive im Wechsel an die Zimmerdecke, LED, 1W, 230V, Ein-Aus-Funktion über Dämmerungssensor, 100 x 90 x 100 mm



80055
Taschenlampen-Projektor Waldtiere

4,5V für 3 Batterien AA, 1,5V, es lassen sich 6 Motive per Dreh-Rad auswählen und projizieren, Batterien nicht im Lieferumfang enthalten, ca. 7 x 15 cm



**80015
Nachtlicht Octopus**

Ein-Aus-Schalter,
Abschaltautomatik nach 30 Min.,
4,5V für 3 Batterien AA, 1,5V,
Batterien nicht im Lieferumfang
enthalten, projiziert Wellen in den ganzen Raum,
15 x 15 x 11 cm



**80017
Nachtlicht Brachiosaurus**

Ein-Aus-Schalter,
4,5V für 3 Batterien AAA, 1,5V,
Batterien nicht im Lieferumfang
enthalten, ca. 22 x 15 x 9 cm



**80019
Projektions-Nachtlicht Beetlestar**

Ein-Aus-Funktion über Berührungssensor,
mit LED-Farbwechsler,
Abschaltautomatik nach 45 Minuten,
4,5V für 3 Batterien AA, 1,5V,
Batterien nicht im Lieferumfang
enthalten, projiziert Sterne in den ganzen Raum,
16 x 16 x 8 cm



**80039
Stecker-Nachtlicht Sunny**

projiziert ein Motiv an die Zimmerdecke,
LED, 1W, 230V,
Ein-Aus-Funktion über Dämmerungssensor,
90 x 80 x 70 mm



**80035
Nachtlicht Solar Heart**

einfaches Aufladen über Solar oder USB-Kabel,
LED-Farbwechsler, EIN-AUS-Schalter,
Saugnapf zum Aufhängen am Fenster,
projiziert Herzen und Sterne
in den ganzen Raum,
ca. 13 x 12 x 5 cm

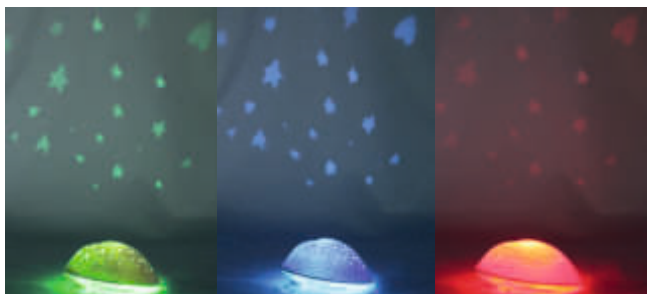

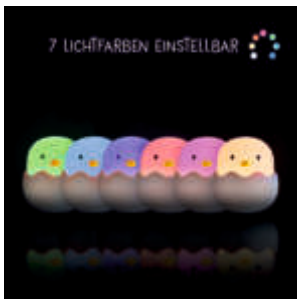

85850
Nachtlicht Eggy Egg

1 x 1,1W LED, 4,5V USB (inkl. Kabel),
dimmbar, Softsilikon, Akku fest verbaut,
RGB-Farbwechsel,
ca. 10 x 10 x 12 cm



85862
Nachtlicht Paddy Panda

1 x 3W LED, 3,7V USB (inkl. Kabel),
dimmbar, Softsilikon, Akku fest verbaut,
Ein-Aus durch Drücken des Schwänzchens,
Timer 20/40/60 Min, RGB-Farbwechsel,
ca. 13 x 10 x 10 cm



85855
Nachtlicht Catty Cat

1 x 1,5W LED, 4,5V USB (inkl. Kabel),
Softsilikon, Akku fest verbaut,
7 Lichtfarben und Soundeffekte,
ca. 12 x 10 x 8 cm



86210
Nachtlicht Maggy Magic

3W LED, 3,7V USB (inkl. Kabel),
dimmbar, Softsilikon, Akku fest verbaut,
Timer 20/40/60 Min,
verschiedene Lichtfarben (RGBW)
ca. 12 x 10 x 11 cm

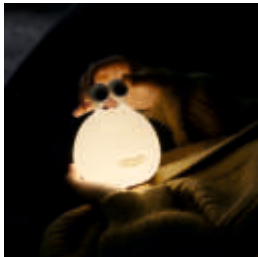

85965
Nachtlicht Momo Moon

1 x 3W LED, 3,7V USB (inkl. Kabel),
dimmbar, Softsilikon, Akku fest verbaut,
ca. 12 x 10 x 12 cm

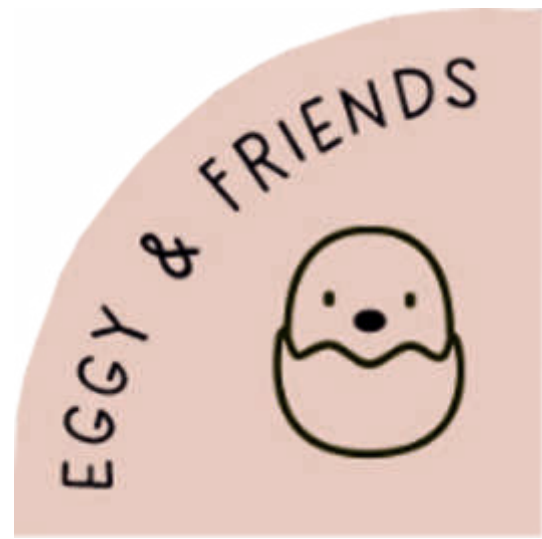

87404
Nachtlicht Diggy Dino

3W LED, 3,7V USB (inkl. Kabel),
3-stufig dimmbar, Softsilikon, Akku fest verbaut,
3000K warmweiß, verschiedene Lichtfarben,
Geräusche/Sound (zu- und abschaltbar),
ca. 12 x 10 x 11 cm

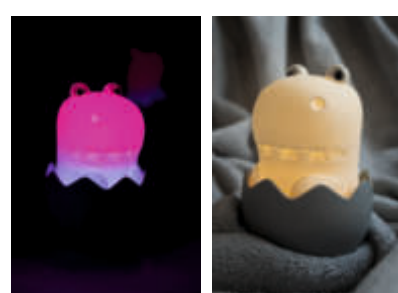
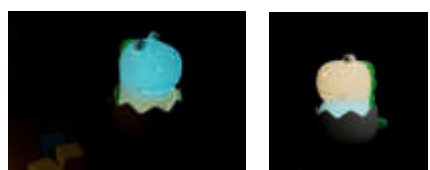

/),



579
Dekoleuchte Kuh Daisy

1 x 1,5W LED, 12V,
Eurostecker-Netzteil mit Zwischenschalter,
26 x 22 x 16 cm
Dekoleuchte - Kein Spielzeug



577
Dekoleuchte Katze Felix

1 x 1,5W LED, 12V,
Eurostecker-Netzteil mit Zwischenschalter,
27 x 23 x 17 cm
Dekoleuchte - Kein Spielzeug



578
Dekoleuchte Schaf Dolly

1 x 1,5W LED, 12V,
Eurostecker-Netzteil mit Zwischenschalter,
26 x 25 x 19 cm
Dekoleuchte - Kein Spielzeug



582
Dekoleuchte Krokodil Hector

1 x 1,5W LED, 12V,
Eurostecker-Netzteil mit Zwischenschalter,
25 x 22 x 22 cm
Dekoleuchte - Kein Spielzeug





Accessoires

3496
Mobilehalter Natur

Klemmbereich 3 cm,
Metallzwinde, Sicherungsschraube

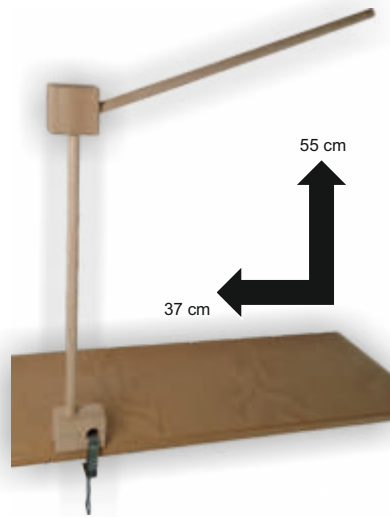

3498
Mobilehalter weiß, XL

Klemmbereich 4 cm,
Metallzwinde, Sicherungsschraube

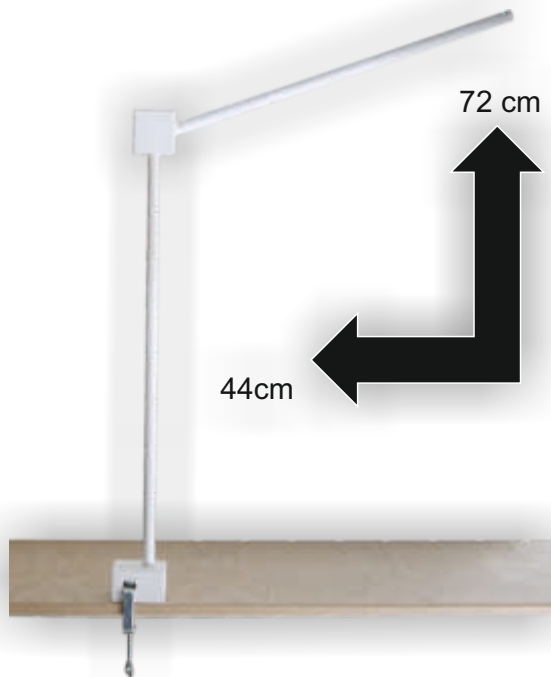

3497
Mobilehalter Natur, XL

Klemmbereich 4 cm,
Metallzwinde, Sicherungsschraube

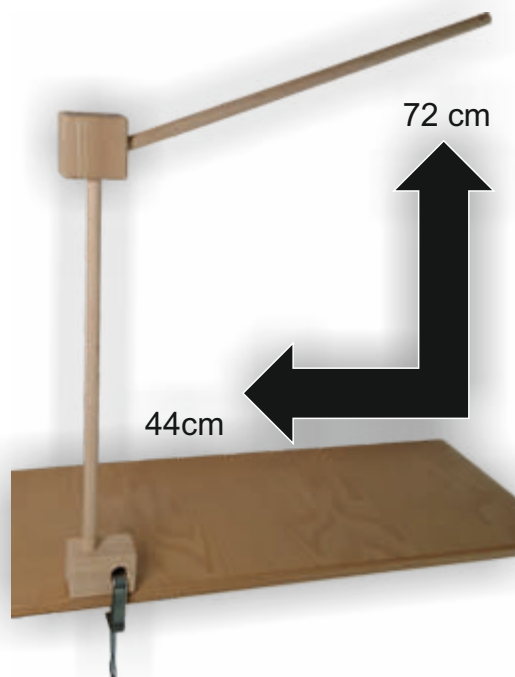



inkl. Aufhängung,
33 x 33 cm

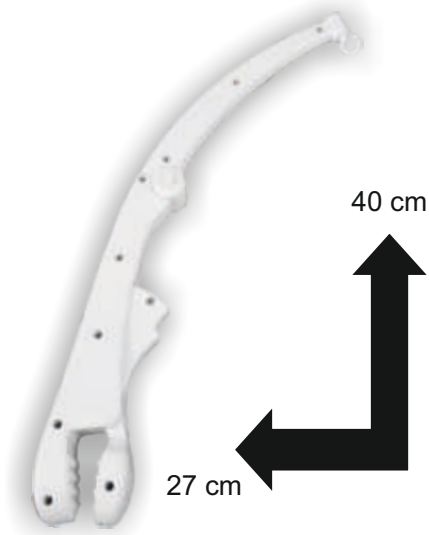

3488
Mobilehalter zum Klemmen

Klemmbereich ca. 4 cm



Mobilehalter
inkl. Spieluhr
Art.Nr. 3489



inkl. Aufhängung,
33 x 33 cm

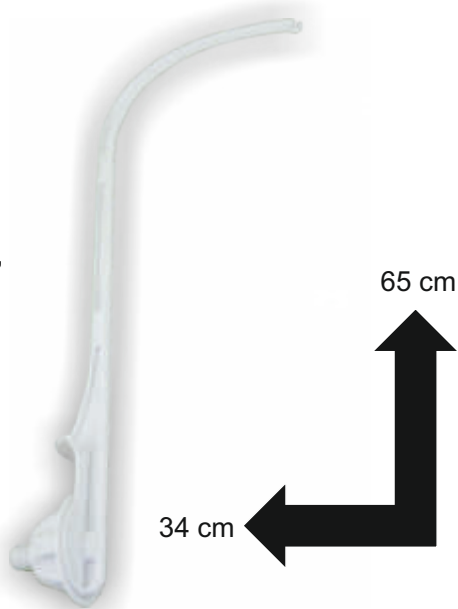

3499
Mobilehalter zum Schrauben

Klemmbereich ca. 5 cm



Mobilehalter
inkl. Spieluhr
Art.Nr. 3491



inkl. Aufhängung,
33 x 33 cm

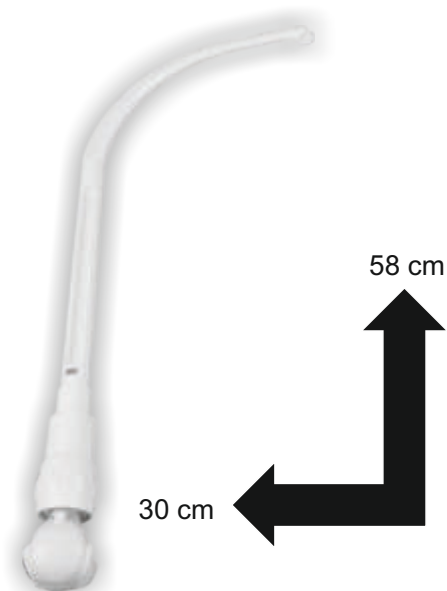

3492
Mobilehalter für Rundstäbe

Klemmbereich ca. 6 cm



Mobilehalter
inkl. Spieluhr
Art.Nr. 3493



9463
Happy-Tanzbär

Kein Spielzeug



9016
Die Bunte Lichterraupe

9teilig, ohne Teelichter und Zahl

Kein Spielzeug



(VE = 5 Stück)

- 9611 = 1
- 9612 = 2
- 9613 = 3
- 9614 = 4
- 9615 = 5
- 9616 = 6
- 9617 = 7
- 9618 = 8
- 9619 = 9
- 9620 = 0



9458
Happy-Maus

Kein Spielzeug



9450
Happy-Prinzessin

Kein Spielzeug



9454
Happy-Kapitän

Kein Spielzeug



3404
Mobile Sum Sum
ca. 50 x 30 x 60 cm

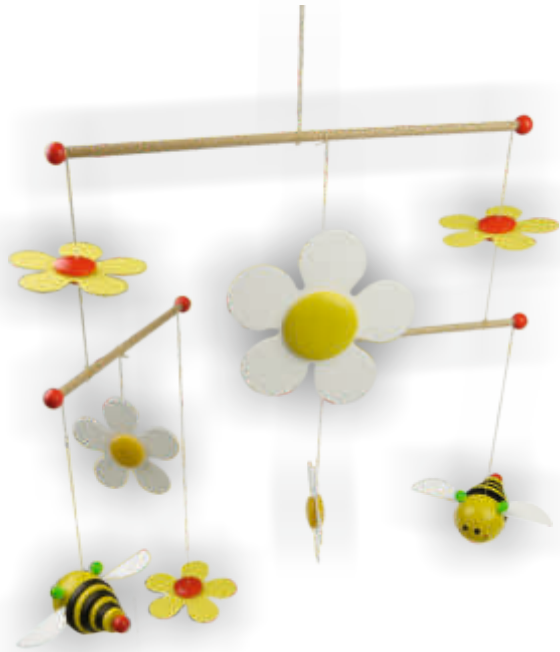

3407
Mobile Segelboote
ca. 50 x 30 x 60 cm



3445
Mobile Fische
ca. 30 x 30 cm,

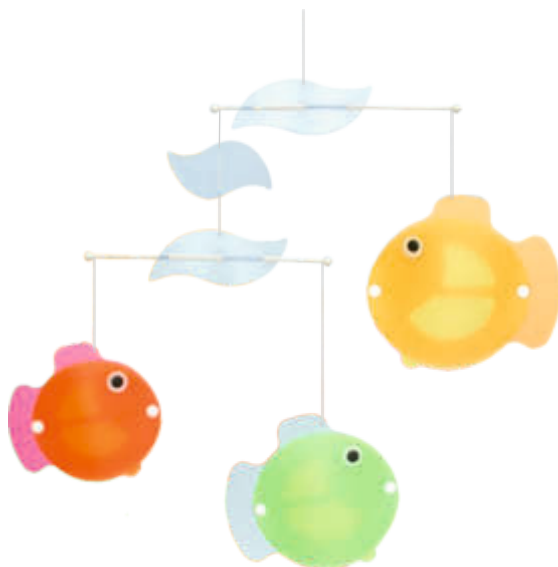

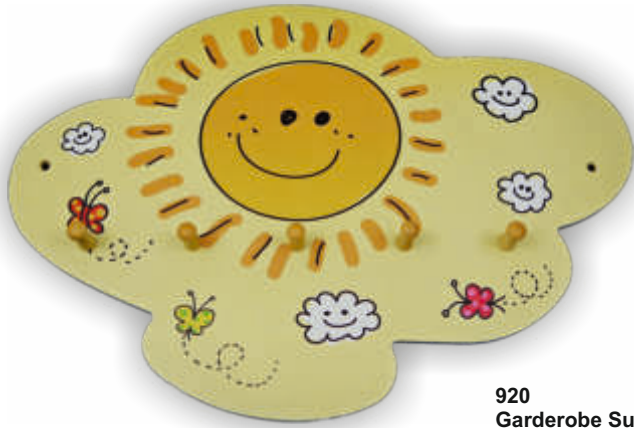

920
Garderoberhelfer Sunny

55 x 38 cm



922
Garderoberhelfer Waldtiere

55 x 38 cm



923
Garderoberhelfer Princess

55 x 38 cm



924
Garderoberhelfer Bunte Blumen

55 x 38 cm

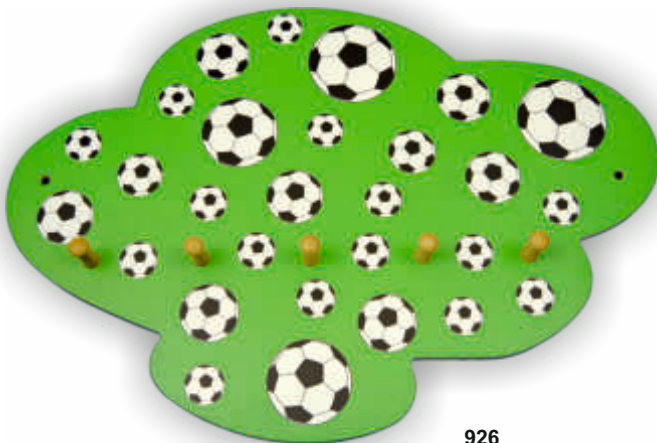

926
Garderoberhelfer Fußball

55 x 38 cm



928
Garderoberhelfer Pirat

ca. 40 x 30 cm





1084
Greifling Pair



1056
Greifling Barry



1113
Greifling Beans



1065
Greifling Rolly



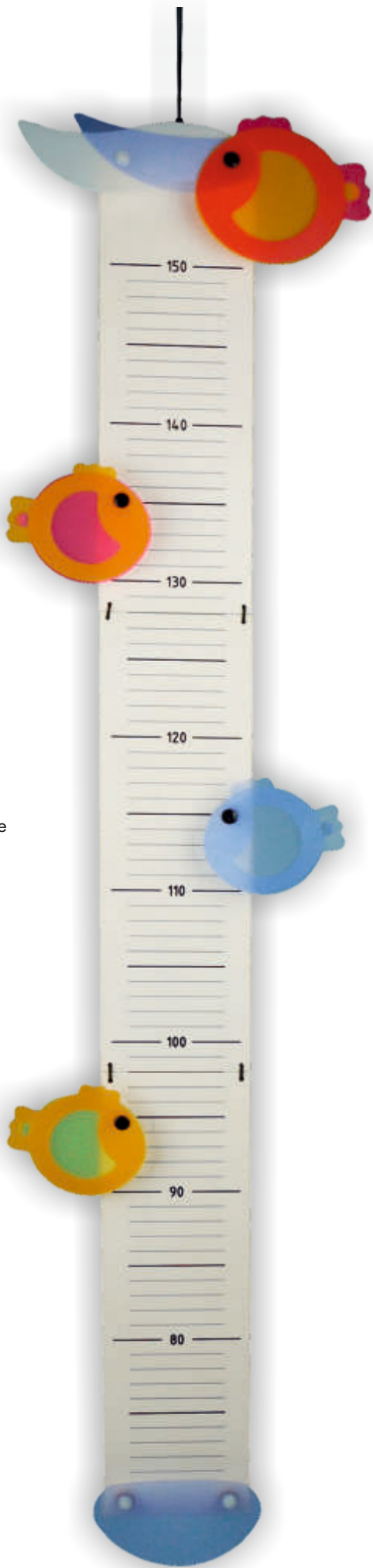

945
Messlatte Fische



946
Messlatte Libelle



niermann

STANDBY

Niermann Standby e.K.

Heinrich-Lübke-Straße 50
D-59759 Arnsberg - Hüsten

Tel: 0049 - (0) 2932-313 62
Fax: 0049 - (0) 2932-348 67

info@niermann-standby.de
www.niermann-standby.de

